



WELCOME TO OCC APPAREL

EST. 2004

Since 2004 we have focussed all our energy on providing our customers with the world's best garments, fabrics and printing methods whilst maintaining our core belief of true sustainable and ethical practices.

This guide will hopefully outline exactly what we do and how we can work together.

We specialise in helping apparel brands, fashion companies, not for profit organisations, political parties, unions, brands and small and corporate businesses obtain the best quality and most ethical printed garments and fabrics in the fastest turnaround times at the best price.

This is our sole purpose and passion, please read on and let us know how we can help yours.
Please ask us about our discount program for not for profit organisations.

OUR BRANDS

BRANDS	ETHICAL	MADE IN	FABRICS	ACCREDITATIONS	DELIVERY
	✓	AUSTRALIA	100% ORGANIC COTTON		IN STOCK or MADE TO ORDER 2-3 WEEKS
	✓	INDIA	100% ORGANIC COTTON	 	SOME STOCKED or ORDERED IN 5-8 DAYS
	✓	TURKEY	COTTON, BAMBOO, TENCEL	 	SOME STOCKED or ORDERED IN 5-8 DAYS
	✓	INDIA	RECYCLED POLY, COTTON	 	ORDERED IN 5-8 DAYS
	✓	INDIA	100% ORGANIC COTTON	 	ORDERED IN 5-8 DAYS
	✓	BANGLADESH/ TURKEY	100% ORGANIC COTTON, MODAL, TENCEL, LINEN	 	ORDERED IN 5-8 DAYS
	✓	BANGLADESH/ CHINA	100% ORGANIC COTTON, MODAL, COTTON		ORDERED IN 2-4 DAYS
	✓	HONDURAS	25% COTTON, 50% POLY- ESTER, 25% RAYON		ORDERED IN 2-4 DAYS

OUR SERVICES



SCREEN PRINTING



DIGITAL PRINTING



YARDAGE PRINTING



PATTERN MAKING



ACCESSORIES



RELABELLING



EMBROIDERY



CUSTOM DYED FABRIC



CUSTOM MAKING



FINISHING



OCC APPAREL
Since 2004

How to place an order or obtain a quote!

Request an order form by emailing sales@occapparel.com.au



Complete the order form

Save & email it back to your sales contact or to sales@occapparel.com.au. Please contact us at any time for assistance.



Optional Decorations

If you require printing, relabelling or other decorations, please supply your labels and print ready art files. For more information please request for Custom Manufacturing and/or Decoration & Finishing PDF.



Quote Confirmation

We'll confirm the pricing and email you an official sales order. Double check it's all correct then please process your payment so we can get everything underway. ***Please notify us of any strict deadlines**, or else standard timeframe applies.

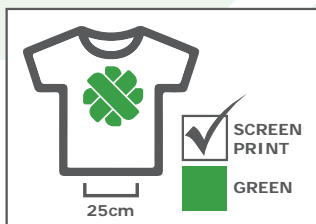

Mockups

We will provide you with a professional mock-up of your artwork onto your selected garments.



Stock

Meanwhile, we will organise your stock. If ordering blank garments your order will be dispatched as soon as your stock arrives.



Printing

We aim to complete printing within 10 days of mock-up approval. ***Complex and/or large quantity jobs may take longer to complete.**



Quality Control/ Dispatch

Your order is dispatched once it's undergone Quality Control. Once dispatched you will receive tracking information for the delivery of your order.

Certton®

Our purpose is simple.

Provide the workers at our Sydney Factory with a safe, clean and enjoyable working environment, pay them a fair wage, supply them with our high quality Australian made fabric, knitted from 100% organic cotton and our Australian made t-shirts will be the best in the world.

A combination of the ultimate cut and the finest 100% organic cotton fabric is the foundation which constructs our bestselling t-shirt. Whilst incorporating the brands core belief of true sustainable and ethical practices, Certton garments are manufactured in Sydney, Australia

We stock a range of classic styles and colours which we manufacture in our factory. Other colours can be custom made for a minimum of 100 per style and we can add your custom label to your Australian made garments.

We're certain of the quality of our t-shirts, fabrics and working conditions, you can be too.





BEST-SELLING Australian Made Styles



**F200 MEN'S FASHION
FITTED TEE**

Stock held in Black, White,
Charcoal, Vintage Navy, Grey Marle



**F201 WOMEN'S FASHION
FITTED TEE**

Stock held in Black, White,
Charcoal, Vintage Navy, Grey Marle



**F204 MEN'S FITTED
LONGSLEEVE TEE**

Stock held in Black, White



**F205 WOMEN'S FITTED
LONGSLEEVE TEE**

Stock held in Black, White



**F300 MEN'S
FITTED SINGLET**



**F301 WOMEN'S
FITTED SINGLET**



**F203 WOMEN'S FITTED
V-NECK TEE**

Stock held in Black, White

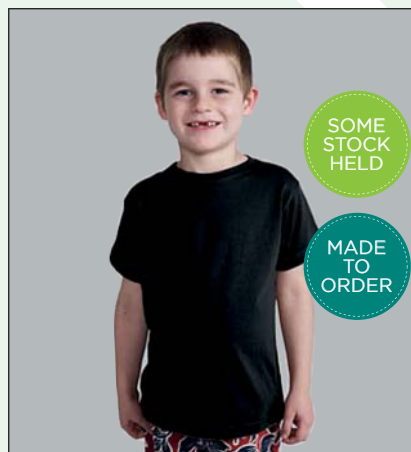

F208/F209 INFANT / KID'S TEE

Stock held in Black, White,
Grey Marle, Vintage Navy



I512 BABY ONESIE

Stock held in White & Natural



OCC APPAREL
Since 2004

GLOBAL BRANDS

We have selected the world's leading t-shirt brands to distribute as they share our belief in ethical manufacturing and in offering superior quality products. They all offer a wide variety of styles that are built for customising with your branding.

These brands hold stock in high volume so opting for an ethically made garment has never been so easy and affordable. Perfect for printing, embroidery and relabelling, your finished garments can be at your door within a matter of weeks.

With no minimum quantity to meet, great styles, eco friendly and sustainable fabrics available you are sure to find something to suit your needs

Let your garments speak volumes about your brand and leave a lasting impression.





- ✓ 100% ORGANIC PRODUCTS
- ✓ VERIFIED ETHICAL MANUFACTURE
- ✓ 90% REDUCED CARBON FOOTPRINT

OCC Apparel partnered with **Earth Positive** in 2010 as their official Australian distributor as a perfect complement to our existing business philosophy. Manufactured in a world class, environmentally friendly factory that produces 100,000 garments a week, Earth Positive represents exceptional value for money for our customers when considering its environmental and ethical credentials.

Earth Positive is a **green revolution** in promotional apparel: Climate Neutral Clothing.

Organic and ethically made, but crucially is manufactured solely using sustainable energy generated from wind and solar power. **Earth Positive** apparel is made to demonstrate the highest possible environmental, social and ethical standards. It has been calculated that a single **Earth Positive** t-shirt saves around 7kg of CO₂, whereas a hooded sweatshirt saves up to 28kgs of greenhouse gases! In January 2008, Continental Clothing Co. Became the first brand in the world to calculate the carbon footprint and place the Carbon Reduction label on textile products.

to check out the full range of styles visit www.continentalclothing.com





BEST-SELLING STYLES



EP01 MEN'S/UNISEX CLASSIC JERSEY T-SHIRT



EP02 WOMEN'S CLASSIC JERSEY T-SHIRT



EP10 MEN'S STANDARD T-SHIRT



EP12 WOMEN'S ROLLED SLEEVE T-SHIRT



EP30 MEN'S GARMENT DYED T-SHIRT



EP17 WOMEN'S RACERBACK VEST



EP20 MEN'S STANDARD POLO T-SHIRT



EP60P MEN'S / UNISEX PULLOVER HOODY



EP70 CLASSIC SHOPPER TOTE BAG

The above is just a small selection of the Earth Positive range, to check out the full range visit; www.continentalclothing.com

Please return to OCC Apparel for more information or to place an order.



INFO

Earth Positive Tagging

Brand Tag

30mm
15mm

Sideseam Tag:
(examples only)

TOP

UNDERSIDE

SEWN IN CUSTOM WOVEN TAG

EP TAG REMOVED + INNER NECK PRINT

We can rebrand your Earth Positive garments with ease with your supplied woven tags or with an inner neck print.
*requires unpicking + resewing garments.

Earth Positive are a great option for:

- ✓ UNIVERSITIES / SCHOOLS
- ✓ FESTIVALS / EVENTS
- ✓ FASHION BRANDS
- ✓ NFP ORGANISATIONS
- ✓ POLITICAL PARTIES
- ✓ BUSINESSES
- ✓ COUNCILS
- ✓ ACTIVIST GROUPS
- ✓ CONSERVATION GROUPS / ZOOS

STOCK HELD IN: AUS/UK/DE
DELIVERY TIME: 3-7 days

DECORATION:

SCREEN PRINTING **DIGITAL PRINTING** **EMBROIDERY**

MADE IN: INDIA
CERTIFICATIONS: Fair Wear, Soil Assoc, GOTS, Confidence in Textiles, Reducing CO2 with the Carbon Trust

To check out the full range visit www.continentalclothing.com
Please return to **OCC Apparel** for more information or to place an order.





OCC Apparel offers FAIR SHARE, a brand that gives back to the community who are the heart of the manufacturing process of the brands that we love to wear and enjoy. More of the profit from these blank garments provide additional wage to support their living.

FAIR SHARE fashion offers quality products and offer more benefits to the workers.

The aim of the FAIR SHARE project is to pay all the workers a living wage. To make this happen, we conducted a survey with the workers and a local NGO. We wanted to find out how much money a family with two adults and two children needs for a decent standard of living in their community in India.

Most garment workers are employed on the legal minimum wage, which is usually much below the living wage level. They earn more as they become better qualified and occupy more senior positions. However, even then they still do not earn as much as they need for a decent standard of living.

Since the start of the FAIR SHARE project in January 2016, all the workers receive a living wage premium with their monthly wages.

The project so far only takes around 10% of the factory's production capacity, so for now everyone receives extra 650 rupees. This is not a living wage yet, but if we can extend the project, every worker will get at least the living wage.

to check out the full range of styles visit www.continentalclothing.com





AVAILABLE STYLES



**FS01 MENS / UNISEX
T-SHIRT**



**FS09 WOMENS
T-SHIRT**



**FS60P MENS / UNISEX
PULLOVER HOODIE**

The above is just a small selection of the Fair Share range, to check out the full range

visit; www.continentalclothing.com

Please return to OCC Apparel for more information or to place an order.



SALVAGE

OCC Apparel is committed to offering the Australian market the most innovative ways of reducing wastage and minimising the impact on the environment of the apparel sector. Salvage offers a range that adheres to this philosophy without costing the earth.

Salvage

Salvage turn trash into treasure by refashioning waste into an inspirational style.

garments are manufactured from 100% recycled materials. The cuttings from organic textile production are shredded and turned back into soft organic cotton fibres. Fibres made from locally recycled plastic bottles are added to the soft cotton fibres to obtain the organic cotton and polyester blend. The blended fibres are then spun into fine yarn to make the fabrics into a variety of coloured melange heathers.

Offering tee's, sweats and totes, Salvage is ethically manufactured in India from 60% Organic Cotton and 40% Recycled Polyester.

to check out the full range of styles visit www.continentalclothing.com



Global
Recycle
Standard



AVAILABLE STYLES



SA01 UNISEX CLASSIC FIT T-SHIRT



SA02 WOMEN'S SLIM FIT T-SHIRT



SA22 UNISEX BASEBALL T-SHIRT



SA40 UNISEX RAGLAN SWEATSHIRT



SA41 UNISEX PULLOVER HOODY



SA41Z UNISEX ZIP-UP HOODY



SA60 SHOPPER TOTE BAG



SA61 TOTE SLING BAG

The above is just a small selection of the Salvage range, to check out the full range visit; www.continentalclothing.com
Please return to OCC Apparel for more information or to place an order.



INFO

Salvage Tagging

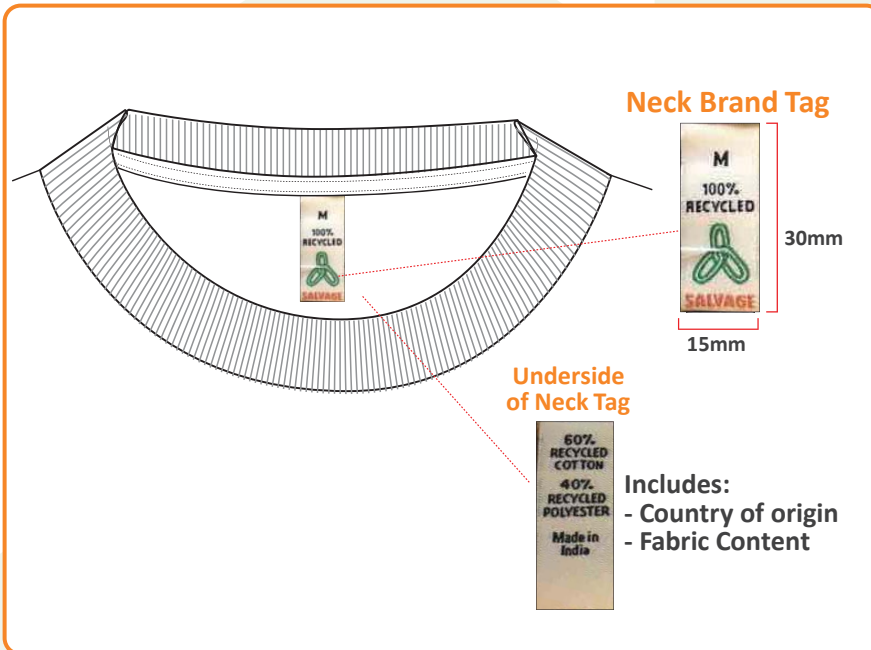

SALVAGE SIDESEAM TAGS



We can rebrand your Salvage garments with ease with your supplied woven tags or with an inner neck print.
Contact us to discuss the options and pricing.

Salvage are a great option for:-

- ✓ UNIVERSITIES
- ✓ FASHION BRANDS
- ✓ SURF BRANDS
- ✓ FESTIVALS / EVENTS
- ✓ ENVIRONMENT GROUPS
- ✓ NFP ORGANISATIONS



STOCK HELD IN: AUS/UK/DE
DELIVERY TIME: 3-7 days

SUITABLE FOR:



SCREEN PRINTING



DIGITAL PRINTING



EMBROIDERY

MADE IN: INDIA

CERTIFICATIONS: Fair Wear, Organic Blended Content Standard, Global Recycle Standard

To check out the full range visit www.continentalclothing.com
Please return to **OCC Apparel** for more information or to place an order.



stanley stella

OCC Apparel is proud to be the Australian distributor for this groundbreaking organic range. With our in-house garment production we can customise, print and finish your garment programs quickly and to the highest quality standards.

Stanley & Stella produce an extensive range of certified organic clothing across 91 on trend colours.

Their collections are made to inspire you with innovative cuts, styling and exclusive fabrics. Stanley & Stella is constantly updating their range to reflect current market trends and the latest fabric developments. Perfect for creating your own fashion label or expanding your existing offering, Stanley & Stella offers the largest range of ethically mad and environmentally responsible fast fashion garments.



Modal



Garment Dyed



Slub Heather



Denim Dyes



Heathers



Shirting

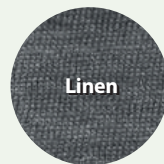

Linen

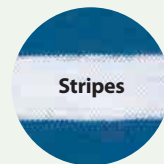

Stripes

to check out the full range of styles visit www.stanleystella.com





**STTM528 STANLEY LEADS
ORGANIC ROUND NECK
T-SHIRT**



**STTW028 STELLA WANTS
ORGANIC ROUND NECK
T-SHIRT**



**STTW001 STELLA DREAMS
ORGANIC RACERBACK
TANK TOPS**



**STTW006 STELLA LOVES
ORGANIC SCOOP NECK
T-SHIRT**



**STPM529 STANLEY PERFORMS
ORGANIC PIQUE
POLO**



**STTM526 STANLEY ADORES
ORGANIC SCOOP NECK
T-SHIRT**



**STTW042 STELLA SHOWS
ORGANIC V-NECK
T-SHIRT**



**STSM607 STANLEY KNOWS
RAGLAN SLEEVE
HOODY**



**STSM322 STANLEY STROLLS
ORGANIC DENIM ROUND NECK
SWEATSHIRT**

The above is just a small selection of the Stanley & Stella range, to check out the full range visit; www.stanleystella.com

Please return to OCC Apparel for more information or to place an order.



INFO

Stanley & Stella Tagging

Size Pip Tag

10mm
13mm

Sideseam Tag

Examples:

TOP	UNDERSIDE	TOP (of tag underneath)

SEWN IN CUSTOM WOVEN TAG

KEEP SIZE TAG + ADD INNER NECK PRINT

We can rebrand your Stanley & Stella garments with ease with your supplied woven tags or with an inner neck print.
*requires unpicking + resewing garments.

Stanley & Stella are a great option for:-

- ✓ FASHION BRANDS
- ✓ RETAIL FASHION STORES
- ✓ UNIVERSITIES
- ✓ FESTIVALS / EVENTS
- ✓ SURF / STREET WEAR LABELS
- ✓ GYM / CROSSFIT / YOGA APPAREL
- ✓ NFP ORGANISATIONS
- ✓ CONSERVATION GROUPS / ZOOS

STOCK HELD IN: AUS/UK/DE
DELIVERY TIME: 3-7 days

SUITABLE FOR:

SCREEN PRINTING **DIGITAL PRINTING** **EMBROIDERY**

MADE IN: BANGLADESH, TURKEY
CERTIFICATIONS: Fair Wear, Soil Assoc, GOTS, Confidence in Textiles

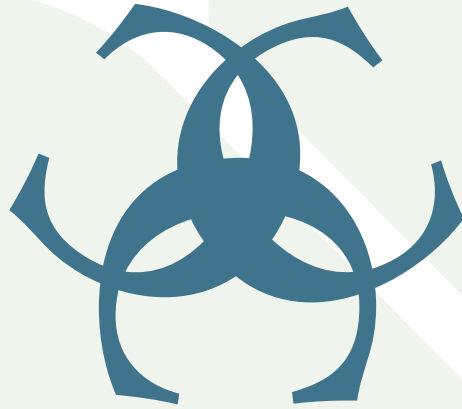

CONTINENTAL®

OCC Apparel has its own manufacturing facility in Sydney and manages offshore production for our clients.

As we understand the complexities of custom production and fabric development, Continental offer our clients an easy way to create or expand their own range of fashion forward garments that are in stock and ready to be customised at our factory within 10 days.

Continental's focus is on creating high quality, expertly styled and ethically made garments for fast fashion, quick to market retail brands.

Continental Clothing Company has a zero tolerance policy with regard to following social responsibility criteria. They offer a range of high end blank garments in singlets, crops, tee's, sweats and hoodies made in Turkey. Their garments come in cotton, bamboo and tencel and are ideal for rebranding.

To ensure that Continental Clothing have made transparent their manufacturing supply chain with independent audits by the non-profit NGO the Fair Wear Foundation'.

to check out the full range of styles visit www.continentalclothing.com





BEST-SELLING STYLES



**N15 MEN'S RAW EDGE
JERSEY T-SHIRT**



**N14 WOMEN'S SLEEVELESS
JERSEY T-SHIRT**



**N13 WOMEN'S RAW EDGE
JERSEY T-SHIRT**



**N18 MEN'S/UNISEX SLIM CUT
JERSEY T-SHIRT**



**N22 MEN'S/UNISEX
BASEBALL T-SHIRT**



**N03 MEN'S CLASSIC CUT
JERSEY T-SHIRT**



**N10 WOMEN'S BAMBOO
OPEN NECK T-SHIRT**



**N47 WOMEN'S BAMBOO ROLLED
SLEEVE TUNIC T-SHIRT**



**N45 MEN'S BAMBOO
JERSEY T-SHIRT**

The above is just a small selection of the Continental range, to check out the full range visit; www.continentalclothing.com

Please return to OCC Apparel for more information or to place an order.



INFO

Continental Tagging

Size Pip Tag

10mm
15mm

Sideseam Tags:

TOP	UNDERSIDE	TOP	UNDERSIDE

SEWN IN CUSTOM WOVEN TAG

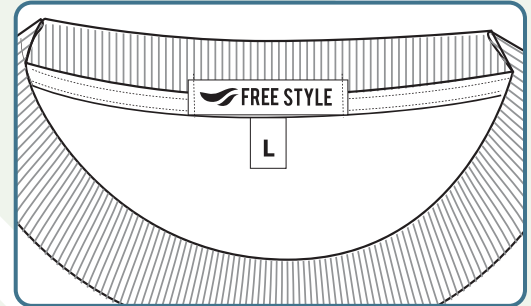

SIZE PIP TAG + INNER NECK PRINT

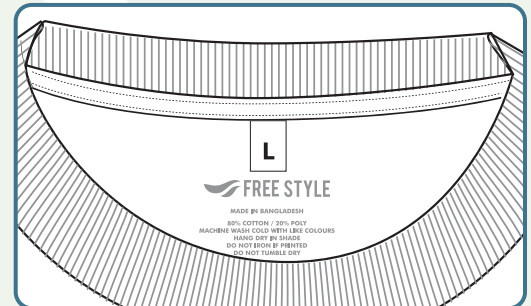

We can rebrand your Continental garments with ease with your supplied woven tags or with an inner neck print.

*requires unpicking + resewing garments.

Continental are a great option for:-

- ✓ FASHION BRANDS
- ✓ UNIVERSITIES
- ✓ BANDS
- ✓ FESTIVALS / EVENTS
- ✓ SURF / STREET WEAR LABELS
- ✓ GYM / CROSSFIT / YOGA APPAREL
- ✓ NFP ORGANISATIONS
- ✓ RELABELLING

STOCK HELD IN: UK/DE
DELIVERY TIME: 3-5 days

SUITABLE FOR:

SCREEN PRINTING

DIGITAL PRINTING

EMBROIDERY

MADE IN: TURKEY
CERTIFICATIONS: Fair Wear, GOTS

To check out the full range visit www.continentalclothing.com
Please return to **OCC Apparel** for more information or to place an order.



ANVIL[®]

OCC Apparel offers ANVIL[®], a brand that celebrates the unique nature of its consumers and their freedom to express themselves. A fashion brand designed to fit and wear with ease, ANVIL[®] is reflective of your modern lifestyle. Versatile, the product contours to you. More than tees, ANVIL[®] provides you with the ultimate fashion wardrobe staples.

ANVIL[®] dares to be different, encouraging you to honour your individual personality and style.

ANVIL[®] is a brand that innovates, and the fabrics that make up our collection provide a full spectrum of options to suit any aspect of your individual life. All of our fabrications are decorator-friendly, boasting a high stitch density for a smoother printing surface to yield a wide variety of successful printing solutions. Tri-Blends are softer than ever with a balanced blend of polyester, combed ring spun cotton and rayon, offering superior comfort in a semi-fitted silhouette. Our new Black fabrication is debuted in a premium enzyme wash tee unlike any you've seen before. Made with ultra-soft, ring spun and combed ring spun cotton, our Lightweight and Midweight t-shirt fabrics are as much about maintaining the perfect "just right" weight as they are about achieving perfect softness. Warm up to our Fleece with a combed ring spun cotton/polyester blend, which is cosy but functional, keeping you on the go, wherever life takes you.

At this current time we are able to offer;

- 6750 / Adult Tri-Blend Tee
- 6750VL / Women's Tri-Blend V-Neck Tee
- 6755 / Adult Tri-Blend 3/4 Sleeve Raglan Tee
- 6751 / Women's Tri-Blend Racerback Tank Tee

to check out the full range of styles visit www.anvilknitwear.com

ANVIL®

TRI-BLEND ACTIVEWEAR



6750 ADULT
TRI-BLEND TEE

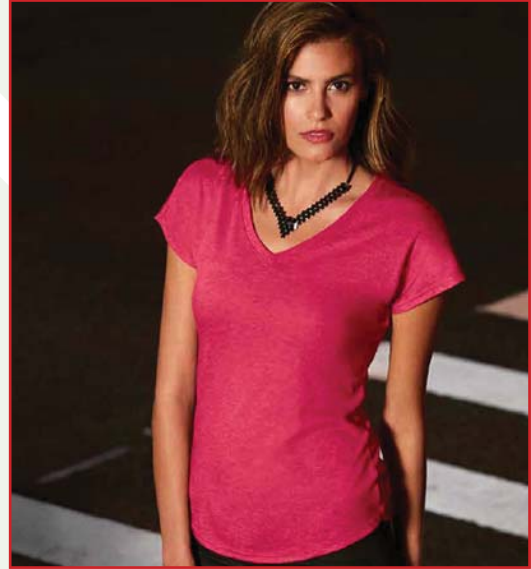

6750VL WOMEN'S
TRI-BLEND V-NECK TEE

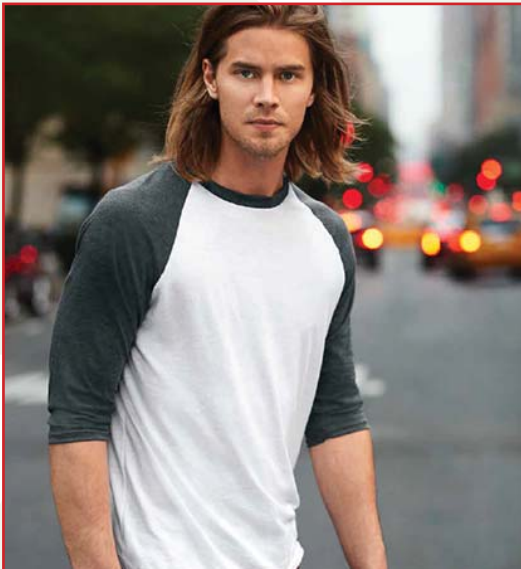

6755 ADULT
TRI-BLEND 3/4 SLEEVE RAGLAN TEE



6751 WOMEN'S
TRI-BLEND RACERBACK TANK TEE

The above is just a small selection of the Salvage range, to check out the full range

visit; www.anvilknitwear.com

Please return to OCC Apparel for more information or to place an order.



INFO

ANVIL® Tagging

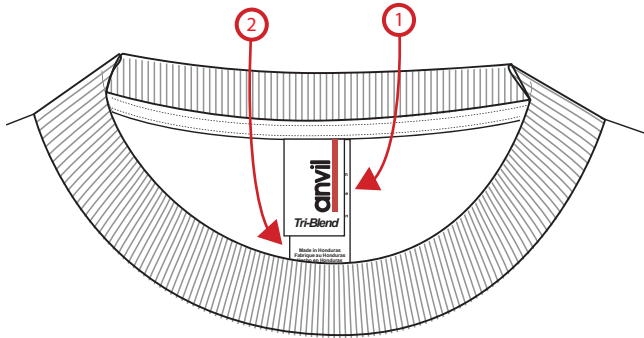

1. Neck Brand Label



TOP
(1st layer)



UNDERSIDE
(1st layer)

2. Composition & Care label

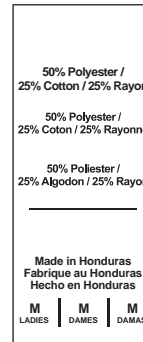

TOP
(2nd layer)

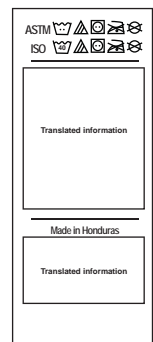

UNDERSIDE
(2nd layer)

We can rebrand your ANVIL® garments with ease with your supplied woven tags or with an inner neck print.
Contact us to discuss the options and pricing.

ANVIL® are a great option for:-

- ✓ ACTIVEWEAR
- ✓ SPORTING CLUBS AND TEAMS
- ✓ CROSSFITS & YOGA
- ✓ UNIVERSITIES



STOCK HELD IN: AUS

DELIVERY TIME: 2-4 days

SUITABLE FOR:

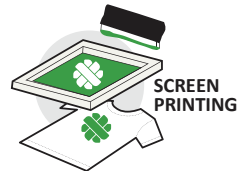

SCREEN PRINTING



DIGITAL PRINTING



EMBROIDERY

MADE IN: HONDURAS
CERTIFICATIONS: WRAP

as colour

OCC Apparel has been working with AS Colour since they began down the road from us in Sydney. Due to our huge printing capacity and technical expertise we offer AS Colour garments at a better price than anyone else in Australia.

AS Colour are a premium blank garment brand aimed at the street savvy and fashion conscious which are stocked in large quantities in Melbourne.

AS Colour specialise in high grade combed cotton, fashion cuts and innovative fabrics. Offering t-shirts, singlets, sweatshirts, pants, shorts, bags and caps makes them a popular choice for streetwear and surfwear brands, bands, festivals, activewear labels, charities and businesses. All their production facilities are WRAP certified, ensuring sweatshop-free product and ethical work conditions.

to check out the full range of styles visit www.ascolour.com.au





BEST-SELLING STYLES



AS5001
MEN'S STAPLE TEE



AS5002
MEN'S PAPER TEE



AS5025
BARNARD TANK TEE



AS4002
WAFER TEE



AS5107
TRACTION ZIP HOOD



AS5025
TALL TEE



AS4008
MALI TEE



AS1001
CARRIE BAG



AS1105
FRACK SNAPBACK CAP

The above is just a small selection of the Stanley & Stella range, to check out the full range visit; www.ascolour.com.au

Please return to OCC Apparel for more information or to place an order.



INFO

AS Colour Tagging

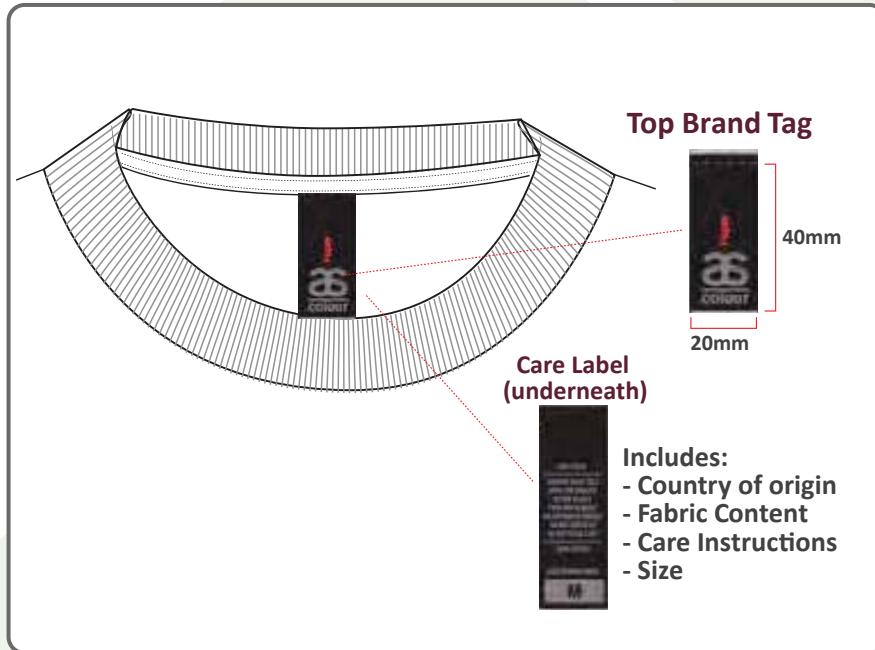

SEWN IN CUSTOM WOVEN TAG



AS TAGS REMOVED + INNER NECK PRINT



We can rebrand your AS Colour garments with ease with your supplied woven tags or with an inner neck print.

*requires unpicking + resewing garments.

AS Colour are a great option for:-

- ✓ UNIVERSITIES
- ✓ BANDS
- ✓ FESTIVALS / EVENTS
- ✓ RETAIL FASHION STORES
- ✓ SURF / STREET WEAR LABELS
- ✓ FASHION BRANDS
- ✓ GYM / CROSSFIT / YOGA APPAREL
- ✓ NFP ORGANISATIONS
- ✓ RELABELLING



STOCK HELD IN: MELBOURNE
DELIVERY TIME: 2-4 days

SUITABLE FOR:



MADE IN: BANGLADESH
CERTIFICATIONS: WRAP

To check out the full range visit www.ascolour.com.au

Please return to **OCC Apparel** for more information or to place an order.

